

Profile Specification

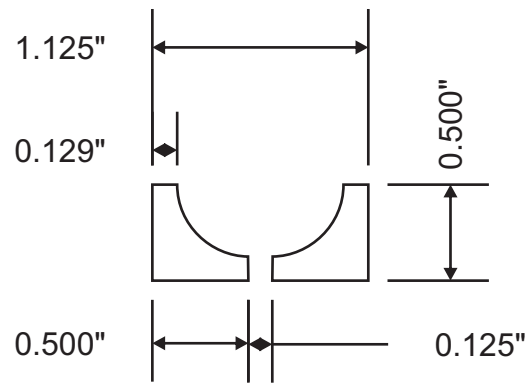

Attention: _____



Customer	Part #	Specie	Dimensions	Notes
	MW3-2008		1/2" x 1/2"	
Revised			Approval Signature	