

Profile Specification

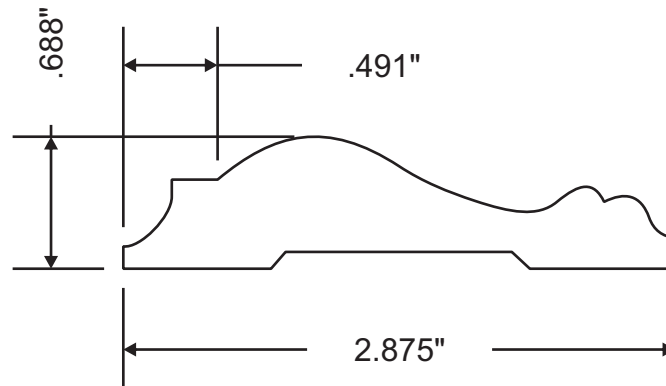

Attention: _____



Customer	Part #	Specie	Dimensions	Notes
	MW3-20231		11/16" x 2-7/8"	
Revised			Approval Signature	