

Profile Specification

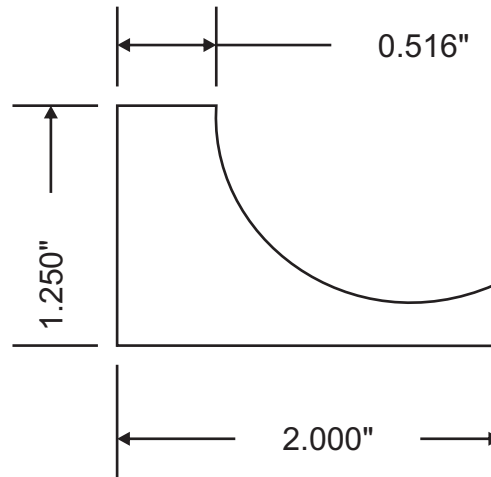

Attention: _____



Customer	Part #	Specie	Dimensions	Notes
	MW3-30551		1-1/4" x 2"	
Revised			Approval Signature	