

Profile Specification

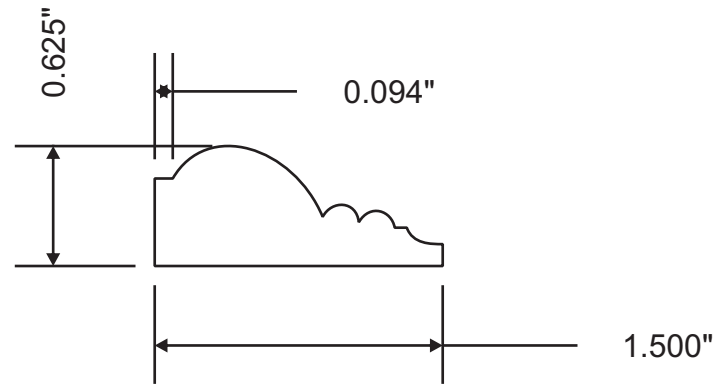

Attention: _____



Customer	Part #	Specie	Dimensions	Notes
	MW3-50079		5/8" x 1-1/2"	
Revised			Approval Signature	