

Profile Specification

# MILLWORK 360

THE DEGREE OF SUPERIOR QUALITY

Attention: \_\_\_\_\_

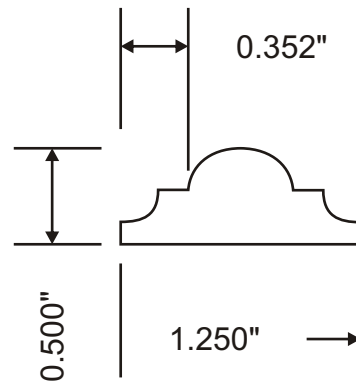

Customer	Part #	Specie	Dimensions	Notes
	MW3-50899		1/2" x 1-1/4"	
Revised			Approval Signature	