

Profile Specification

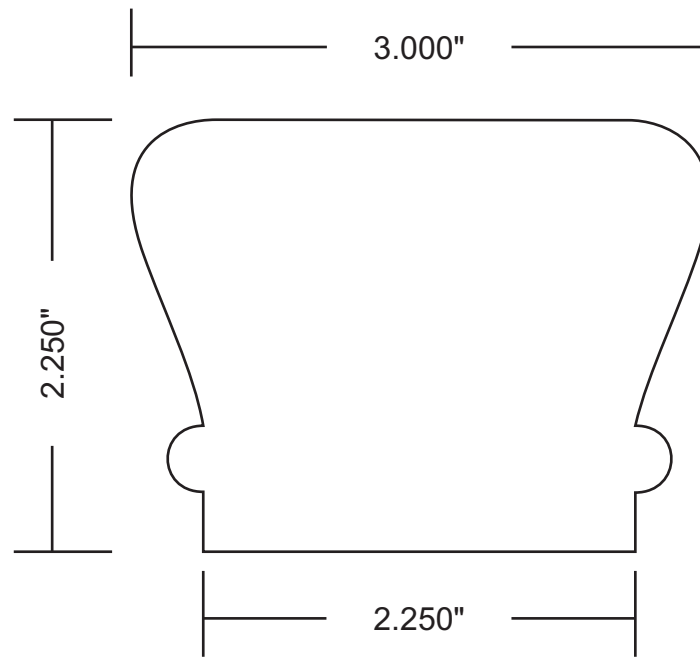

Attention: _____



Customer	Part #	Specie	Dimensions	Notes
	MW3-6026		2-1/4" x 3"	
Revised			Approval Signature	