

DOOR COMPONENT SIZES			
DOOR WIDTH	STILE WIDTH "A"	PANEL WIDTH "B"	PANEL HEIGHT "C"
12" THRU 1-1	2"	VARIABLES	VARIABLES
1-2 THRU 1-3	3"	VARIABLES	VARIABLES
1-4 THRU 1-10	4"	VARIABLES	VARIABLES
2-0 THRU 4-0	4-1/2"	VARIABLES	VARIABLES

NOTES:  
 1. ALL COMPONENTS (STILES, RAILS & MULLIONS) MEASUREMENTS ARE "NET" FACE-WIDTH DIMENSIONS, NOT INCLUDING STICKING PROFILES OR APPLIED MOULDING.

**LEVEL 2 STEP STICKING**

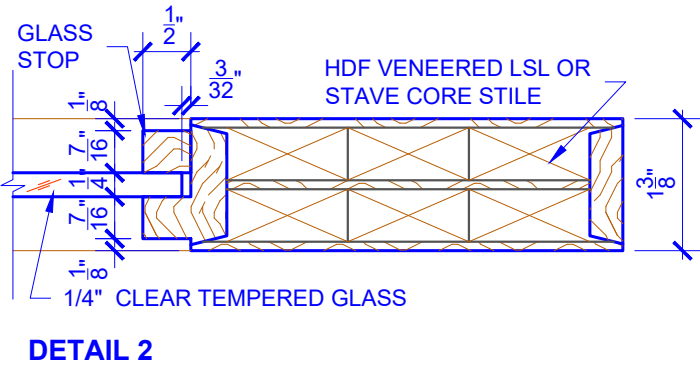
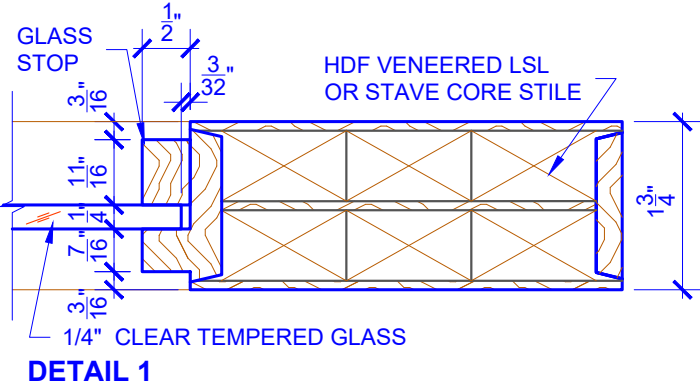

**PASSAGE, POCKET,  
 BYPASS, BARN DOORS**

\* SEE LIMITED LIFETIME WARRANTY FOR TOLERANCES AND EXCLUSIONS



CUSTOMER: \_\_\_\_\_ DATE: 04/28/22

DRAWING TITLE: PNG10101 LEVEL 2 GLASS DOOR

STICKING: STEP SPECIES: HDF STAVE

PO: \_\_\_\_\_

REVISION: \_\_\_\_\_ PAGE: 1 of 1

PANEL: GLASS

