

**PASSAGE, POCKET,
BYPASS, BARN DOORS**

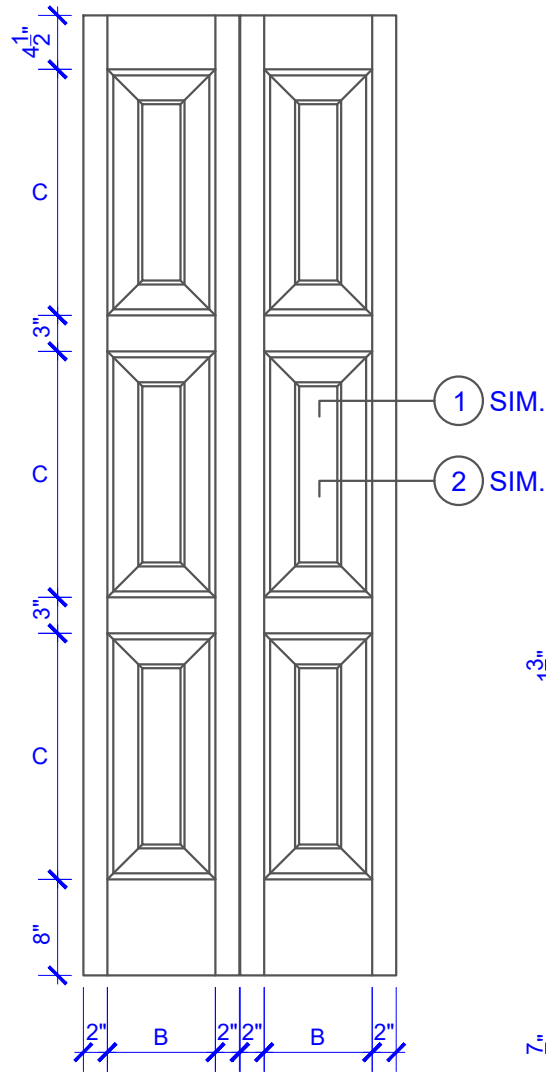

BIFOLD DOORS

DOOR COMPONENT SIZES				
DOOR WIDTH	STILE WIDTH "A"	PANEL WIDTH "B"	TOP PANEL HEIGHT "C"	MIDRAIL WIDTH "D"
2-0 THRU 2-4	4"	VARIES	VARIES	2"
2-6 THRU 4-0	4-1/2"	VARIES	VARIES	3"

NOTES:

- BIFOLD LEAF WIDTHS 10-11/16"-24" WILL HAVE 2" WIDE STILES.
- ALL COMPONENTS (STILES, RAILS & MULLIONS) MEASUREMENTS ARE "NET" FACE-WIDTH DIMENSIONS, NOT INCLUDING STICKING PROFILES OR APPLIED MOULDING.
- DOORS NARROWER THAN 2'-0" IN WIDTH ON 2 PANEL WIDE DOORS WILL BE MADE AS 1-PANEL WIDE IN A CORRESPONDING DESIGN. GP611 DESIGN 1-0 THRU 1-10 WIDE WOULD BE A GP310 PANEL DESIGN.

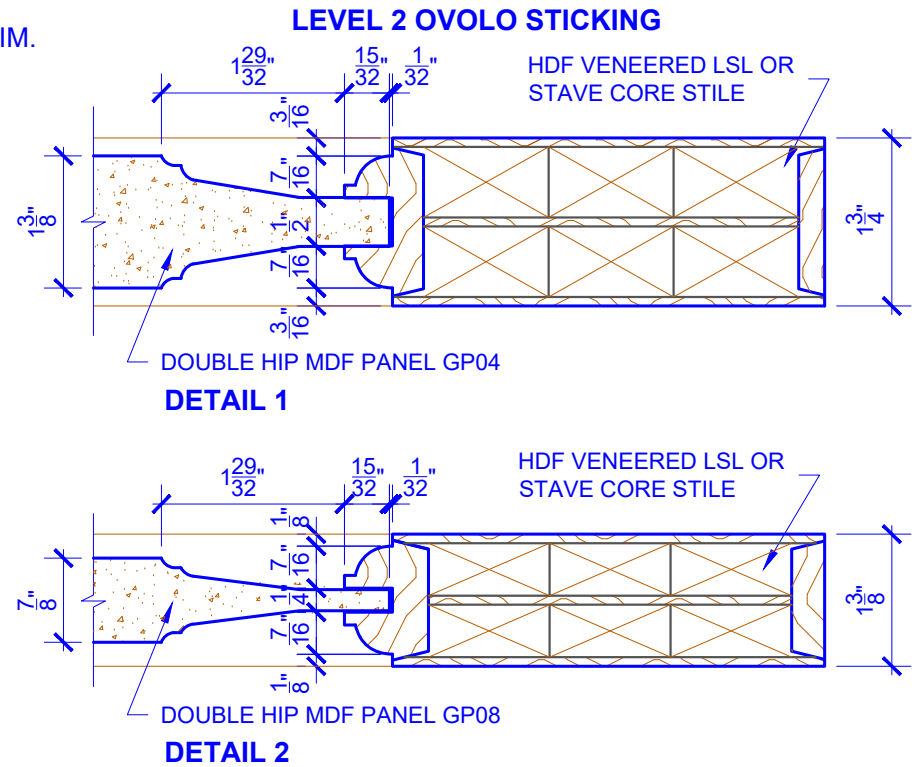

* SEE LIMITED LIFETIME WARRANTY FOR TOLERANCES AND EXCLUSIONS