

**PASSAGE, POCKET,  
BYPASS, BARN DOORS**

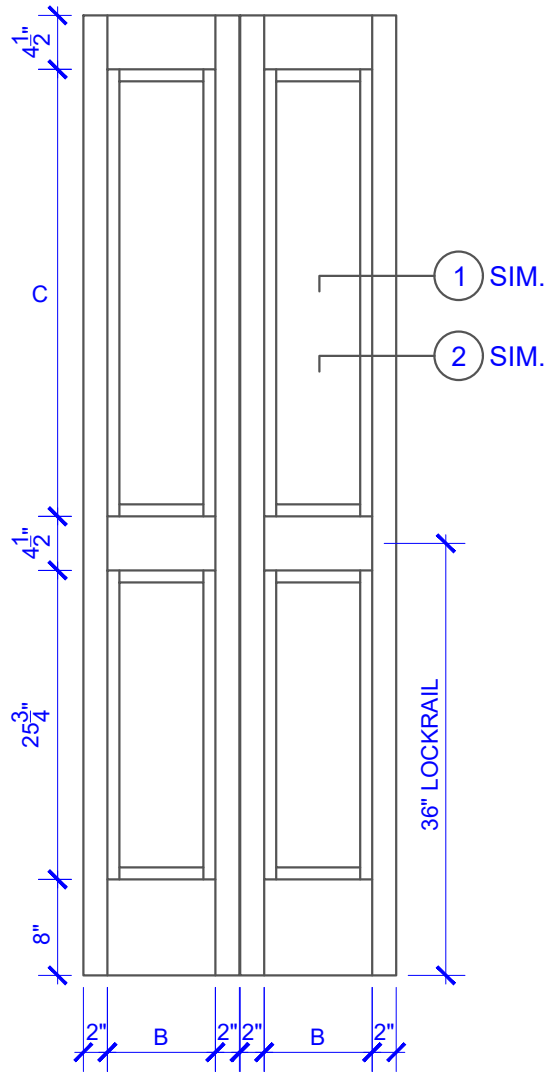

**BIFOLD DOORS**

**DOOR COMPONENT SIZES**

DOOR WIDTH	STILE WIDTH "A"	PANEL WIDTH "B"	TOP PANEL HEIGHT "C"
2-0 THRU 2-4	4"	VARIES	VARIES
2-6 THRU 4-0	4-1/2"	VARIES	VARIES

**NOTES:**

1. BIFOLD LEAF WIDTHS 9"-24" WILL HAVE 2" WIDE STILES.
2. ALL COMPONENTS (STILES, RAILS & MULLIONS) MEASUREMENTS ARE "NET" FACE-WIDTH DIMENSIONS, NOT INCLUDING STICKING PROFILES OR APPLIED MOULDING.
3. DOORS NARROWER THAN 2'-0" IN WIDTH ON 2 OR 3 PANEL WIDE DOORS WILL BE MADE AS 1-PANEL WIDE IN A CORRESPONDING DESIGN. PN325 DESIGN 1-8 WIDE WOULD BE A PN201 DESIGN.

**LEVEL 3 FLAT STEP**

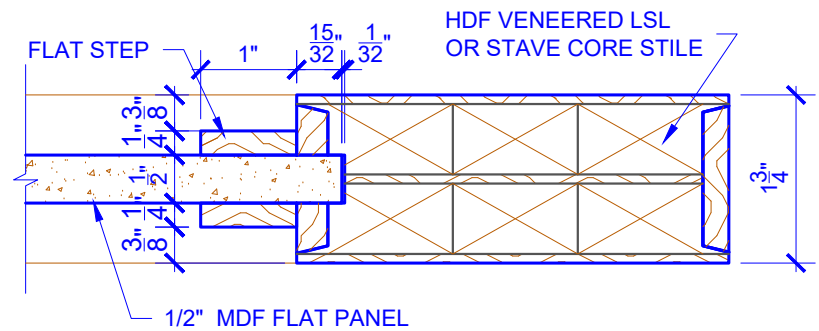

**DETAIL 1**

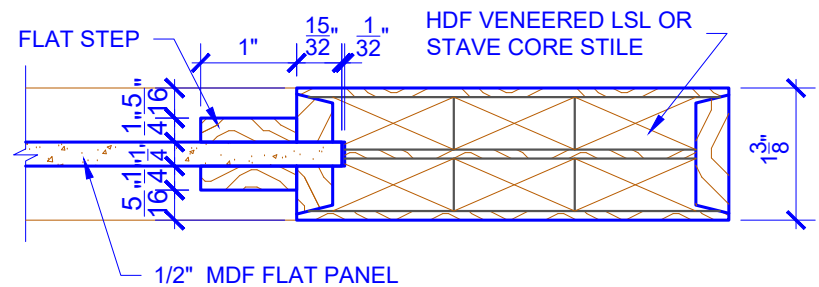

**DETAIL 2**

\* SEE LIMITED LIFETIME WARRANTY FOR TOLERANCES AND EXCLUSIONS