

PASSAGE

DOOR COMPONENT SIZES		
DOOR WIDTH	PANEL WIDTH "A"	PANEL HEIGHT "B"
2-0 THRU 4-0	VARIES	VARIES
NOTES:		
1. ALL COMPONENTS (STILES, RAILS & MULLIONS) MEASUREMENTS ARE "NET" FACE-WIDTH DIMENSIONS, NOT INCLUDING STICKING PROFILES OR APPLIED MOULDING.		

FIRE DOOR SPECIFICATIONS			
20 MINUTE CAT "B" SINGLE FIRE DOOR	CATEGORY "B" MAX SIZE 4/0 X 8/0	CATEGORY "G" EDGE SEAL FOR FIRE CONTROL	CATEGORY "H" EDGE SEAL FOR SMOKE CONTROL (OPTIONAL)
		CHECK BOX IF PROVIDED BY MILLWORK 360 <input type="checkbox"/>	CHECK BOX IF PROVIDED BY MILLWORK 360 <input type="checkbox"/>
NOTES:			
1. CATEGORY "B" DOORS DO NOT HAVE SEALING SYSTEMS BUILT INTO THE DOOR EDGES AND REQUIRE AN ADDITIONAL EDGE SEALING SYSTEM CATEGORY G TO BE APPLIED TO THE DOOR OR FRAME.			
2. TESTING METHOD: 20 MINUTE FIRE DOORS ARE TESTED IN CONFORMANCE WITH THE POSITIVE PRESSURE WITH HOSE STREAM CRITERIA.			
3. TEMPERATURE RISE: OUR FIRE DOORS MEET THE TOP CLASSIFICATION FOR TEMPERATURE RISE FIRE DOORS, WHICH MEANS THE UNEXPOSED FACE OF THE DOOR <i>NON-FIRE SIDE</i> DOES NOT EXCEED 250° F AT 30 MINUTES OF FIRE TESTING.			
4. HARDWARE: ONLY HARDWARE LISTED FOR USE WITH WOOD FIRE DOORS MAY BE INSTALLED.			

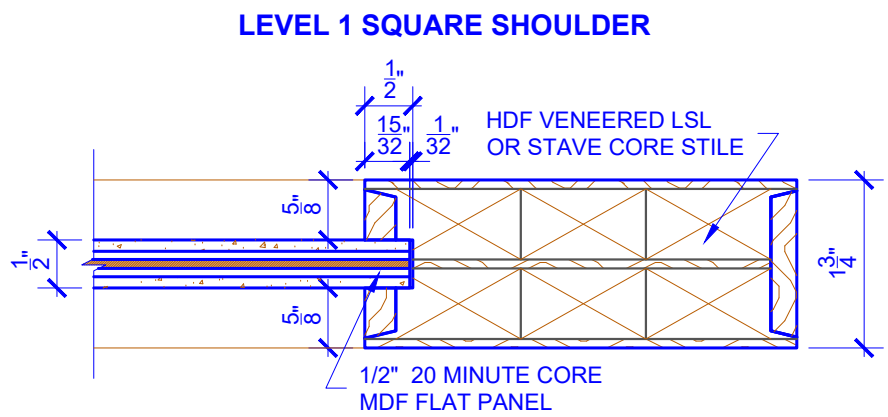

DETAIL 1

* SEE LIMITED LIFETIME WARRANTY FOR TOLERANCES AND EXCLUSIONS



CUSTOMER:	DATE: 08/04/22	PO:
DRAWING TITLE: PNF401 LEVEL 1 CAT "B" 20 MIN. STANDARD DOOR	REVISION:	PAGE: 1 of 1
STICKING: SQUARE	SPECIES: HDF STAVE	PANEL: MDF FLAT

