

DOOR COMPONENT SIZES			
DOOR WIDTH	STILE WIDTH "A"	PANEL WIDTH "B"	PANEL HEIGHT "C"
12" THRU 1-1	2"	VARIABLES	VARIABLES
1-2 THRU 1-3	3"	VARIABLES	VARIABLES
1-4 THRU 1-10	4"	VARIABLES	VARIABLES
2-0 THRU 4-0	4-1/2"	VARIABLES	VARIABLES

NOTES:
1. ALL COMPONENTS (STILES, RAILS & MULLIONS) MEASUREMENTS ARE "NET" FACE-WIDTH DIMENSIONS, NOT INCLUDING STICKING PROFILES OR APPLIED MOULDING.

LEVEL 2 STEP STICKING

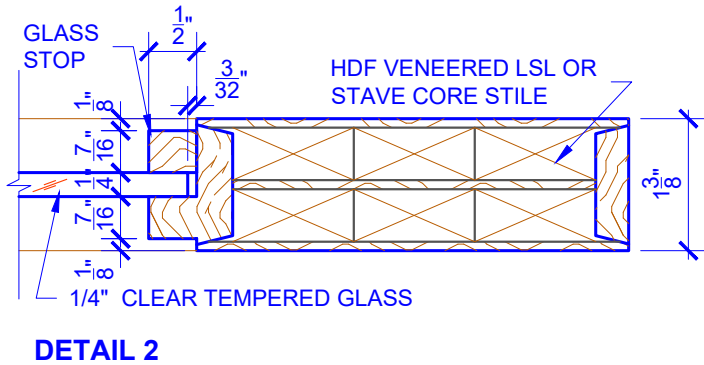
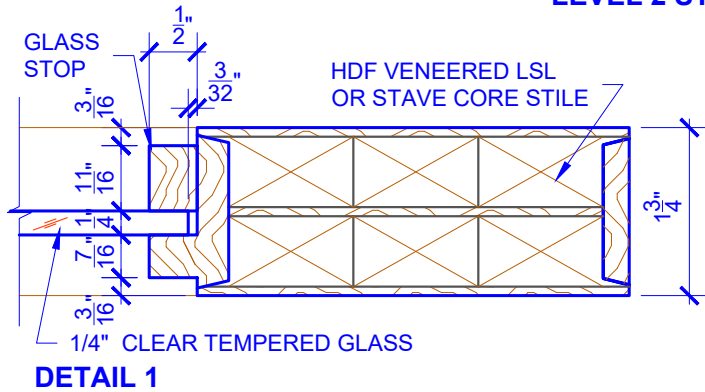

**PASSAGE, POCKET,
BYPASS, BARN DOORS**

* SEE LIMITED LIFETIME WARRANTY FOR TOLERANCES AND EXCLUSIONS



CUSTOMER:	DATE: 04/28/22	PO:
DRAWING TITLE: PNG20102 LEVEL 2 GLASS DOOR	REVISION:	PAGE: 1 of 1
STICKING: STEP	SPECIES: HDF STAVE	PANEL: GLASS

